

Testa di coccodrillo con twist sottogengivali

Roberto Gretter, autunno 2001

Con un cartoncino di dimensioni 70 x 17 cm otterrai una testa di coccodrillo lunga circa 20 cm e con 5 file di denti.
I migliori risultati si ottengono con cartoncino "pelle d'elefante", ma sospetto che cartoncino "pelle di coccodrillo" andrebbe meglio :-)

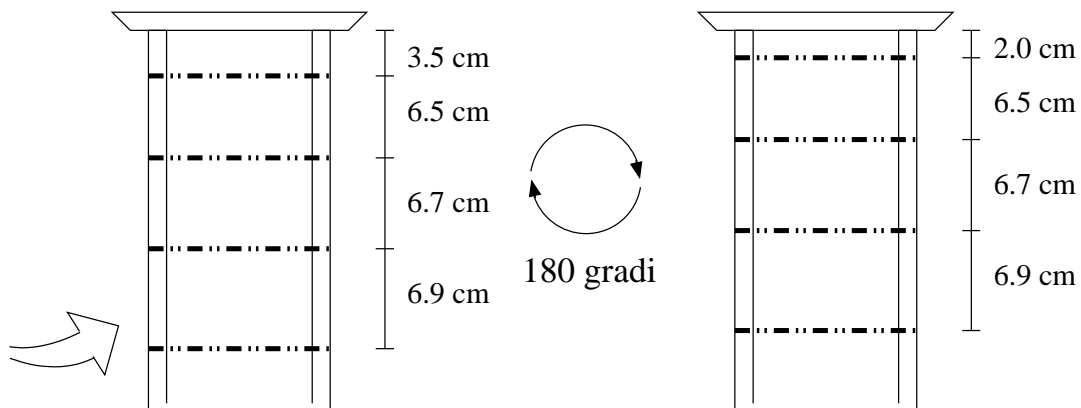
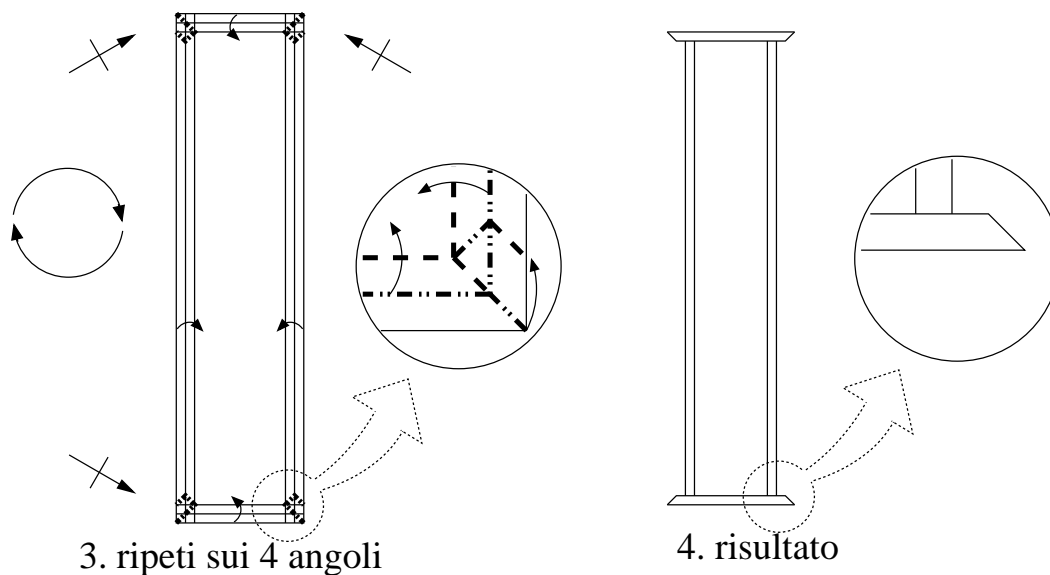
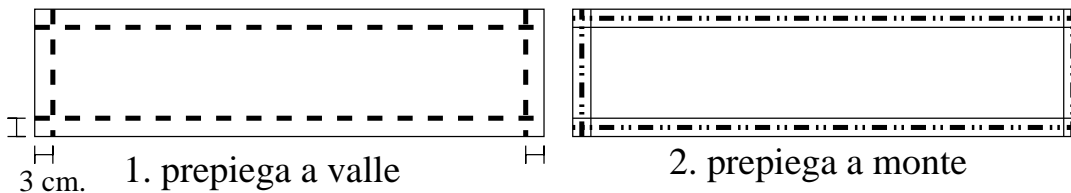

5. mascella inferiore: segna la posizione dei denti (misure indicative)

6. mascella superiore (pieghe sfasate rispetto al passo 5 per ottenere i denti sopra alternati a quelli sotto)



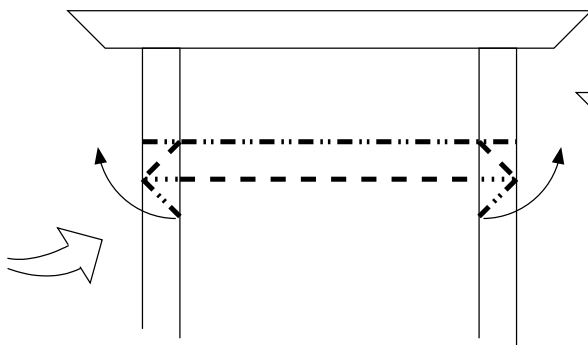

7. primo dente: apri per impostare le pieghe del twist sottogengivale

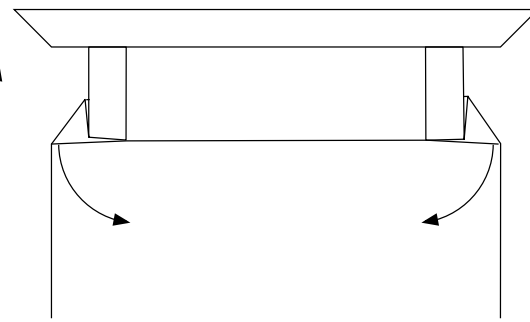

8. richiudi e ripeti il passo 7 sugli altri 3 denti superiori

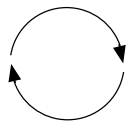

9. gira e ripeti i passi 7 e 8 sui denti superiori, quindi riapri completamente il modello e rovescia alcune pieghe come indicato; nota che i denti sotto sono rovesciati (vedi passo 10)

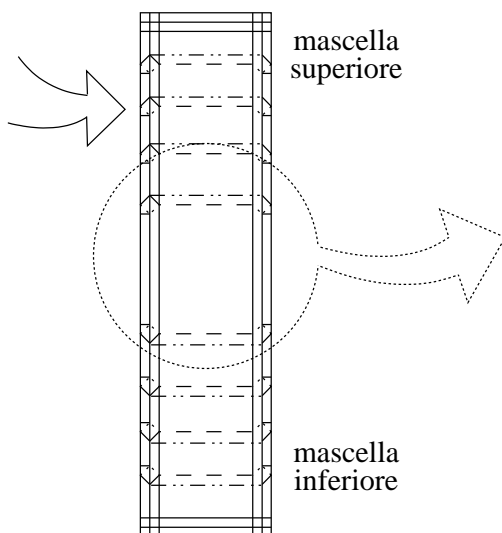
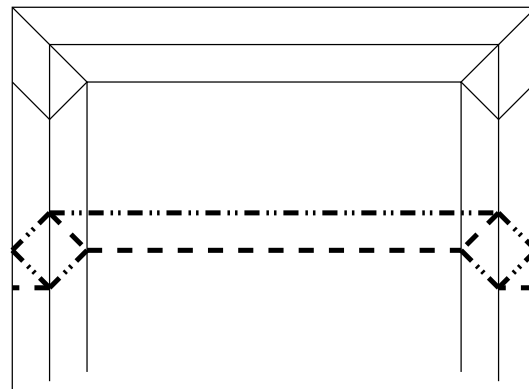

10. esegui i twist partendo dalle due coppie di denti piu' interne e andando verso l'esterno

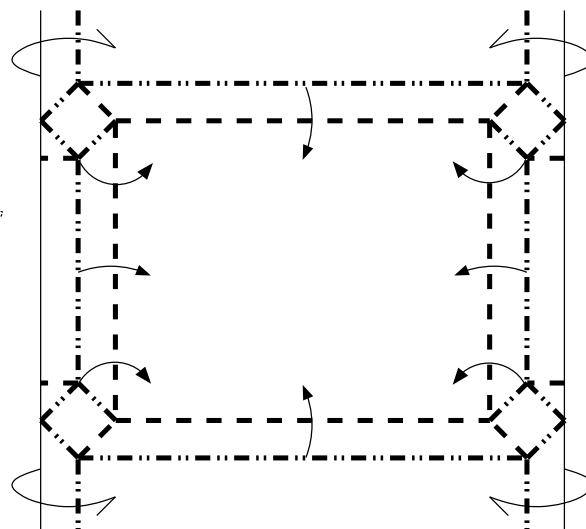

11. primi 4 twist; non chiudere la carta all'esterno della zona mostrata

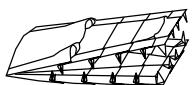

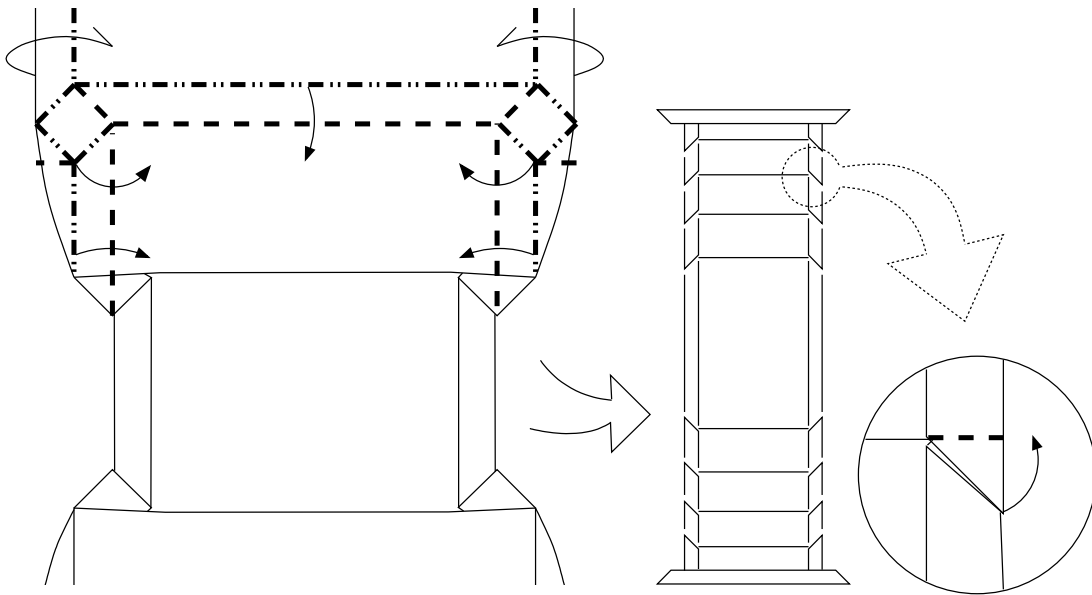

12. i primi 4 twist sono fatti, ora procedi con tutti gli altri (viene mostrato solo il prossimo)

13. ai bordi rifai le pieghe come al passo 3; solleva i denti a 90 gradi

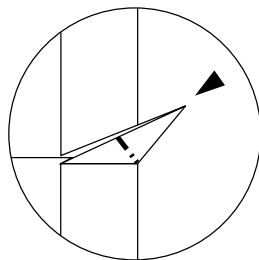

14. piega schiacciata

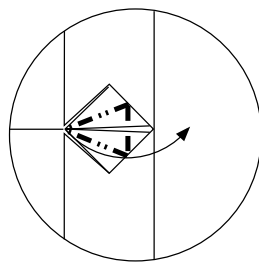

15. piega a petalo

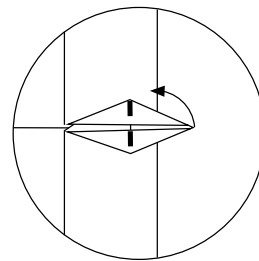

16. solleva a 90 gradi

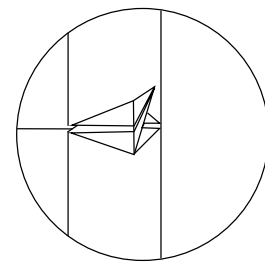

17. ripeti 13-16 su ogni dente laterale

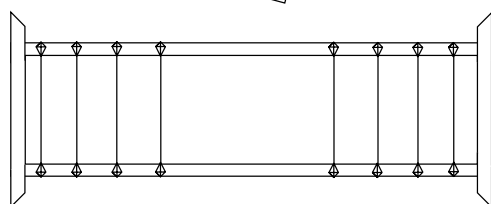
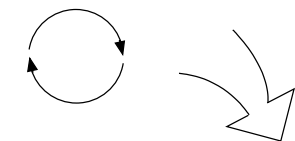

18. vista d'insieme

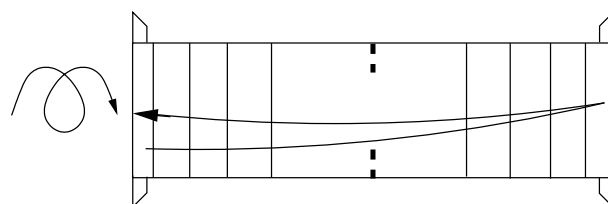

19. segna la meta'



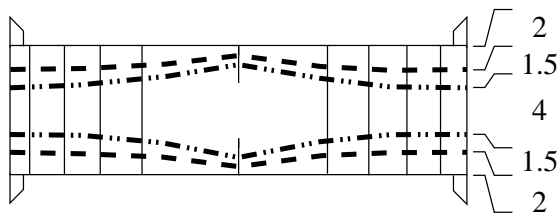

20. misure indicative, eccetto 1.5 usato per i prossimi twist (il lato corto misura 11 cm.); nota che le pieghe sono un po' incurvate

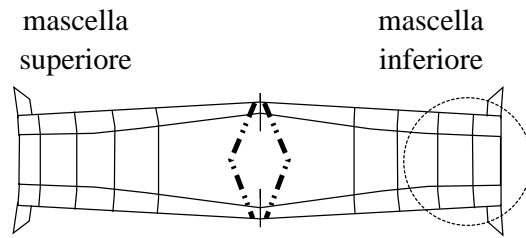

21. prepiega un rombo al centro

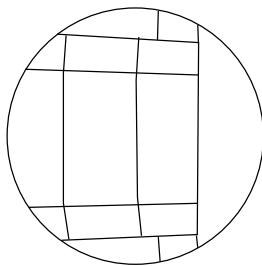

22. gira il modello

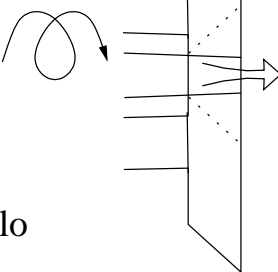

23. estrai la carta al centro

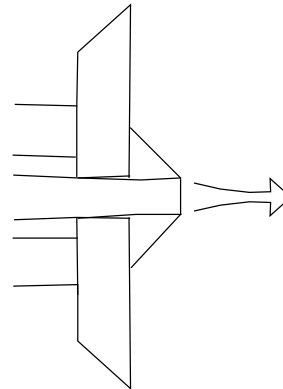

24. riapri la parte davanti

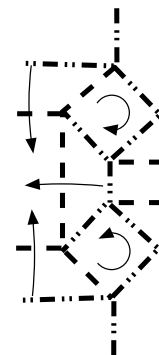

25. esegui i prossimi twist

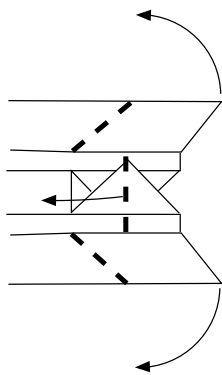

26. richiudi

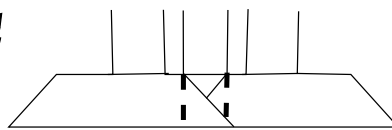
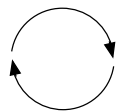

27. ripeti 13-16 sui denti davanti; ripeti 23-27 sulla mascella superiore

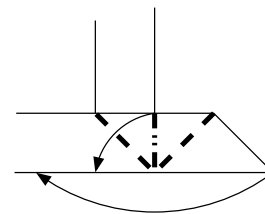

28. dente d'angolo: piega schiacciata



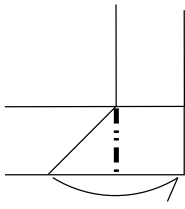

29. infila all'interno

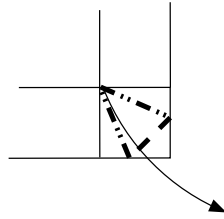

30. piega a petalo

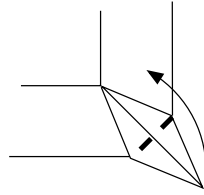

31. solleva a 90 gradi

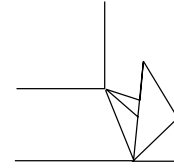

32. ripeti 28-31 sugli altri 3 denti d'angolo

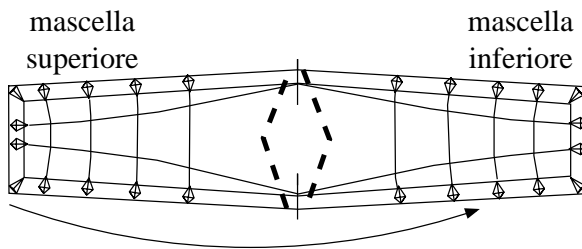

33. chiudi il modello a meta'

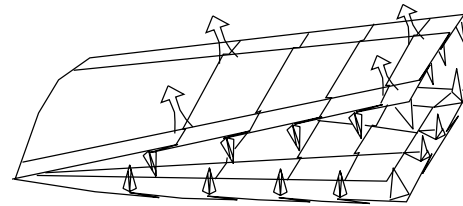

34. estrai carta per formare occhi e narici

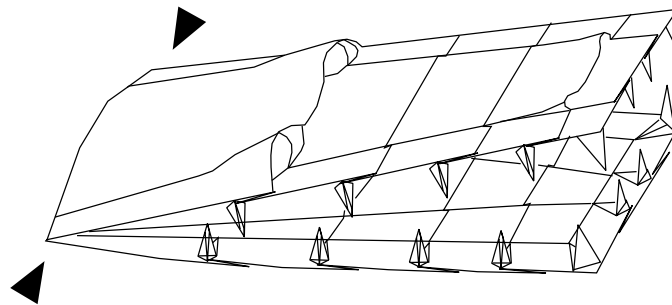

35. testa di cocodrillo con twist sottogengivali; premi dove indicato per farla aprire e chiudere

